

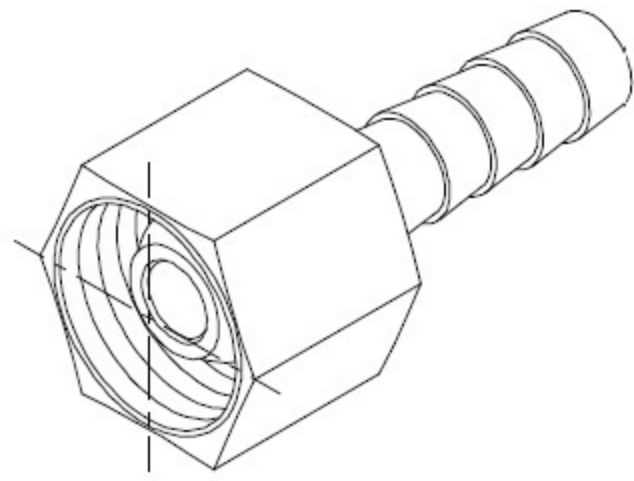

Industrial Specialties Mfg.

An ISO 9001:2008 Certified Company

4091 S. Eliot St., Englewood, CO 80110-4396 • 303-781-8486 FAX: 303-761-7939 • www.industrialspec.com



FBSX-38-8F-B

3/8" Hose Barb
1/2" Female NPSM
Brass

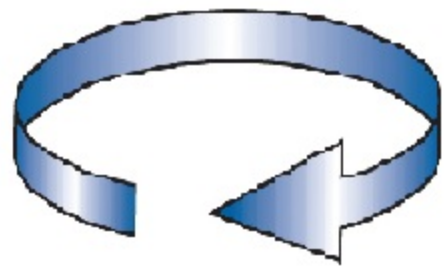

360° Swivel

