

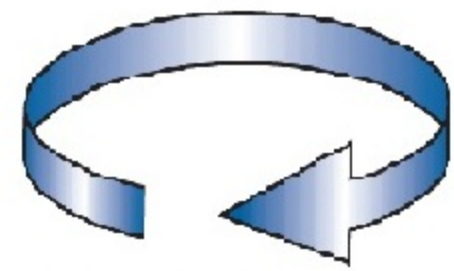

Industrial Specialties Mfg.

An ISO 9001:2008 Certified Company

4091 S. Eliot St., Englewood, CO 80110-4396 • 303-781-8486 FAX: 303-761-7939 • www.industrialspec.com

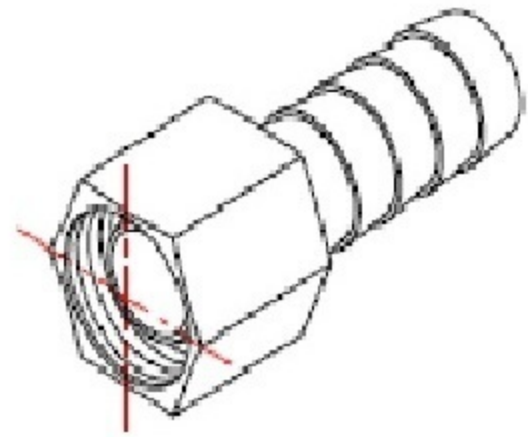

360° Swivel

FBSX-12-6F-B

1/2" Hose Barb
3/8" Female NPSM
Brass

